

Technisches Datenblatt - Fercher Abwasserwärmetauscher Typ FB-60/WS

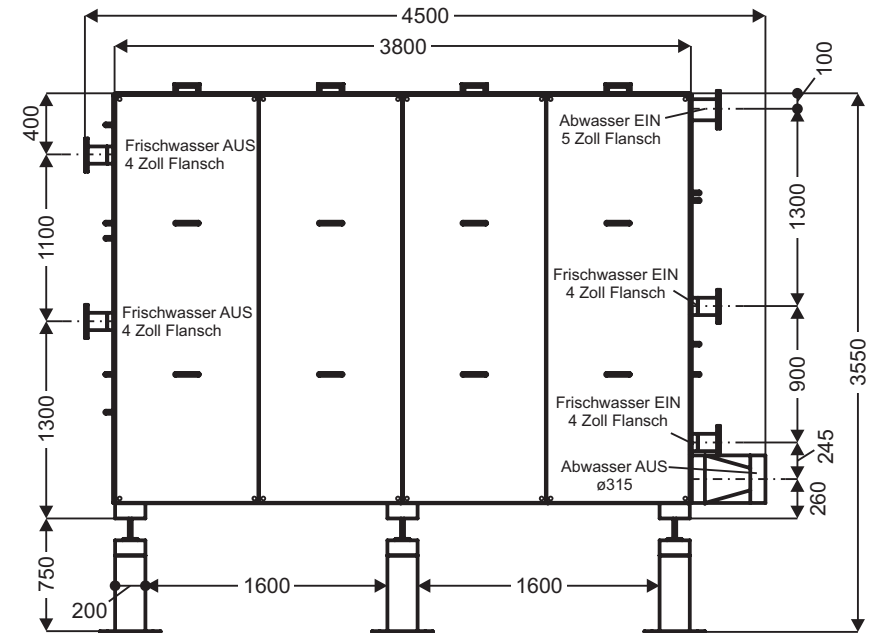
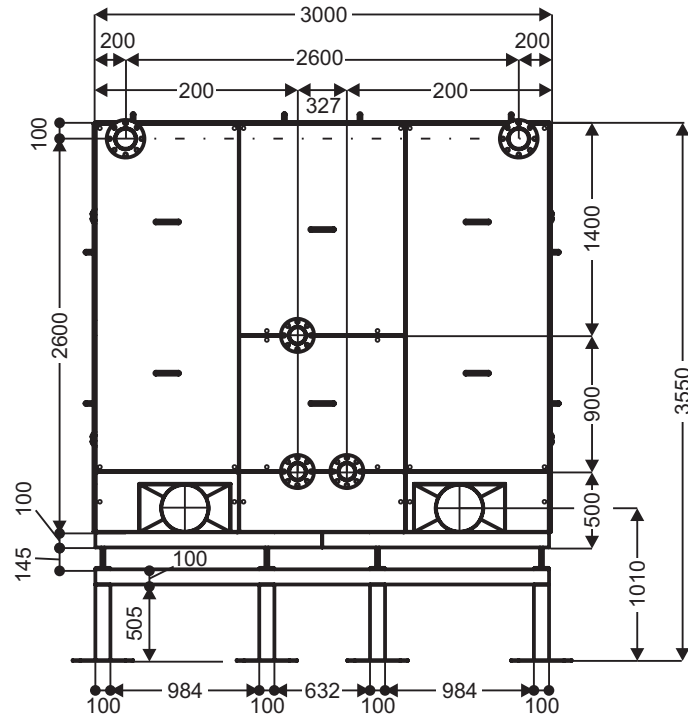

Technische Daten:

Werkstoff: Edelstahl 1.4301 (V2A)
 Nenndurchfluss Abwasser: 120 m³/h
 Nenndurchfluss Frischwasser: 120 m³/h

101029

FERCHER 
 ENTSTAUBUNG - ABLUFT - ABWASSER - ENERGIE

Firma Bernhard FERCHER
 Schießstattgasse 53/4
 A-8010 Graz

Tel. +43 / 676 / 606 9540
 Fax. +43 / 316 / 26 83 70

www.fercher.at
 office@fercher.at

UID-Nr: ATU63293108

Technische Änderungen vorbehalten. Irrtum vorbehalten.

Datenblatt für den FERCHER - Abwasserwärmetauscher Typ FB-16/W

16 Norm-Absorber

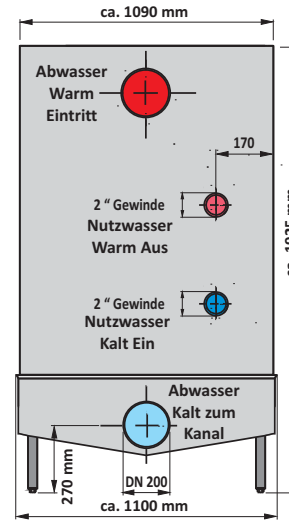
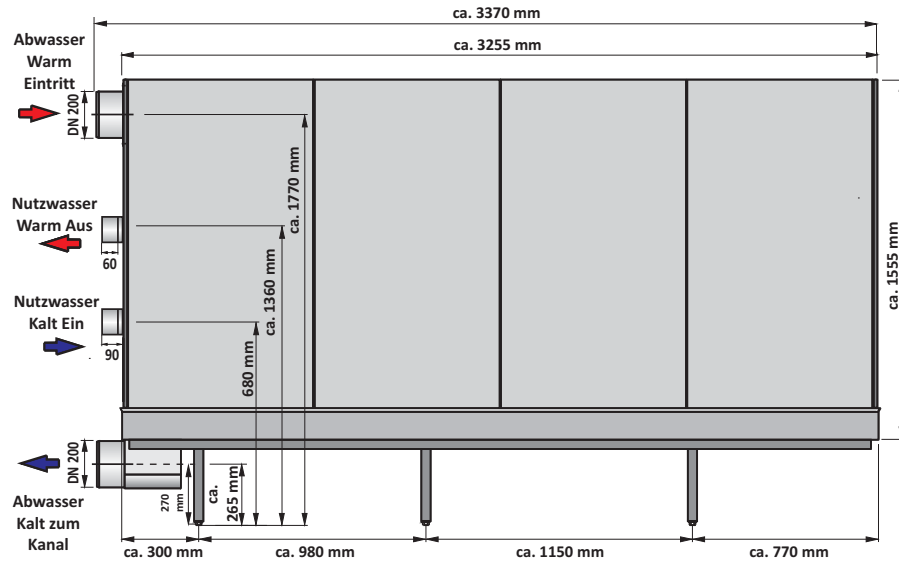

Druckverlust Nutzwasser:

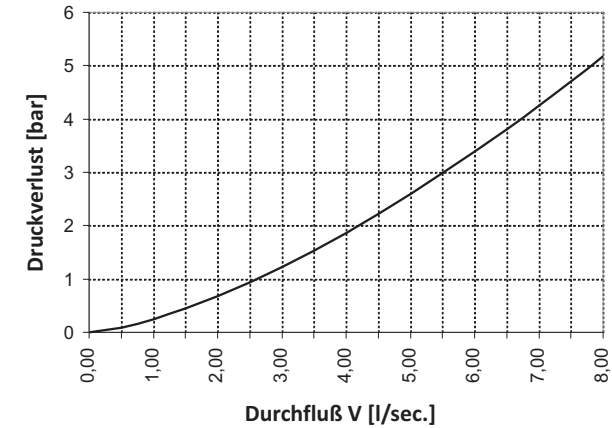

Temperaturkennlinien:

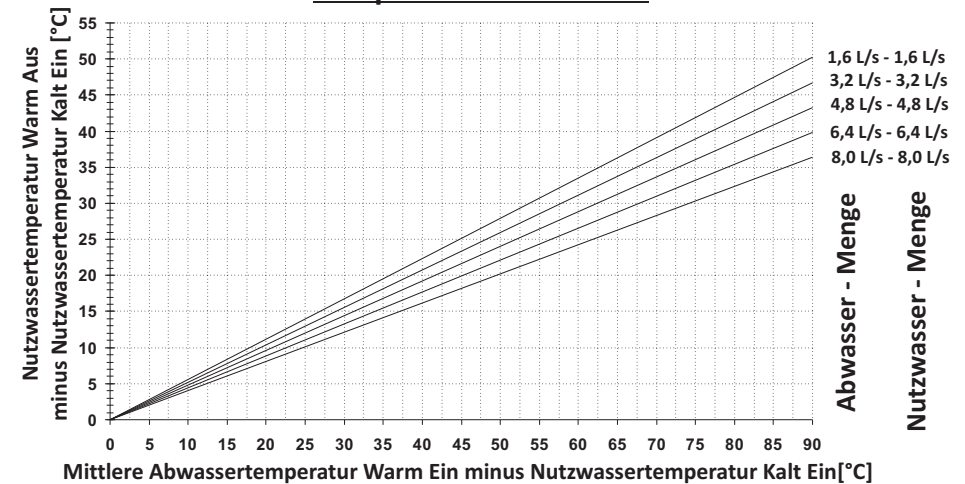

101029

Datenblatt für den FERCHER Abwasserwärmetauscher Typ FB-12/W

12 Norm-Absorber

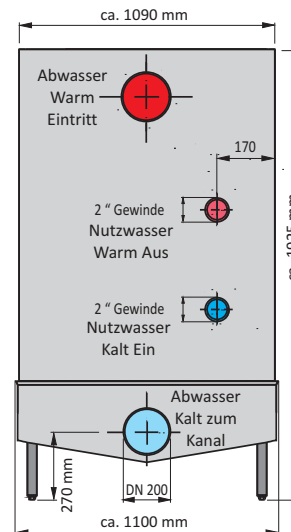
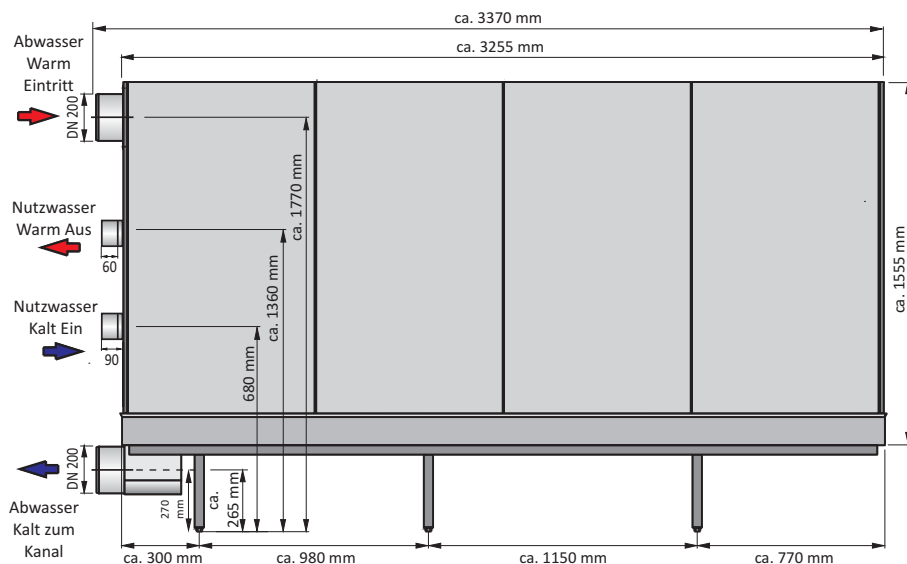

Druckverlust Nutzwasser:

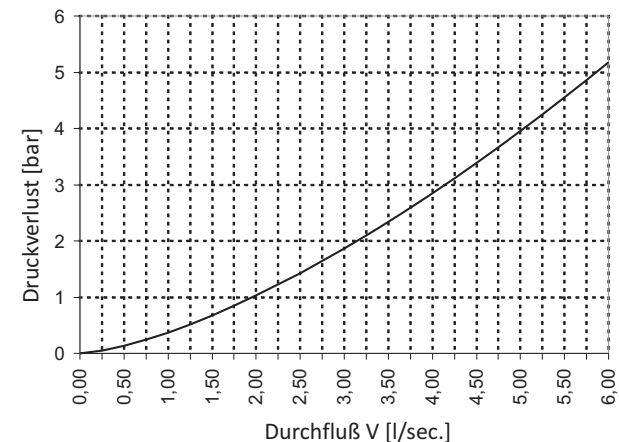

Temperaturkennlinien:

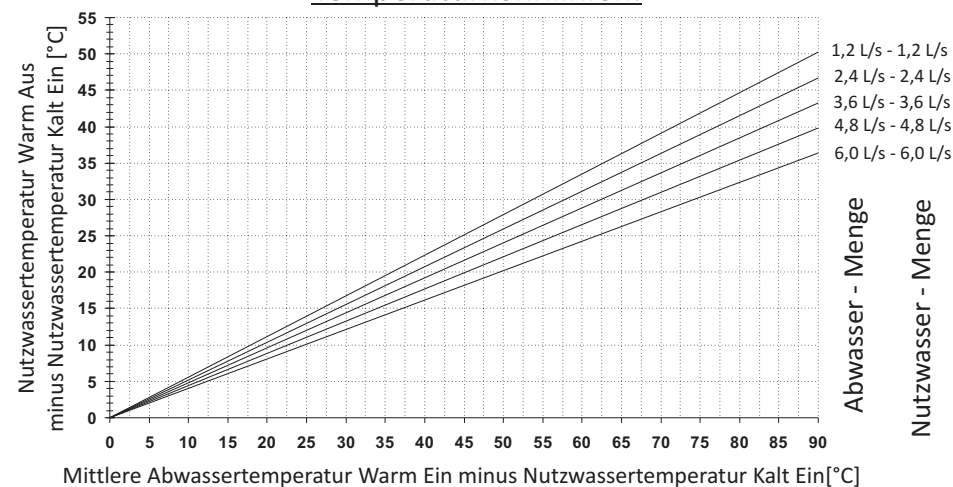

101029

Datenblatt für den FERCHER - Abwasserwärmetauscher Typ FB-8/S 8 Norm-Absorber

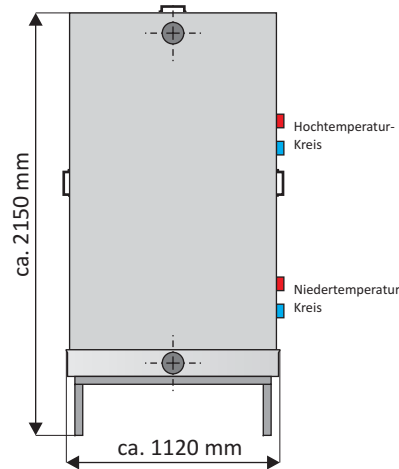
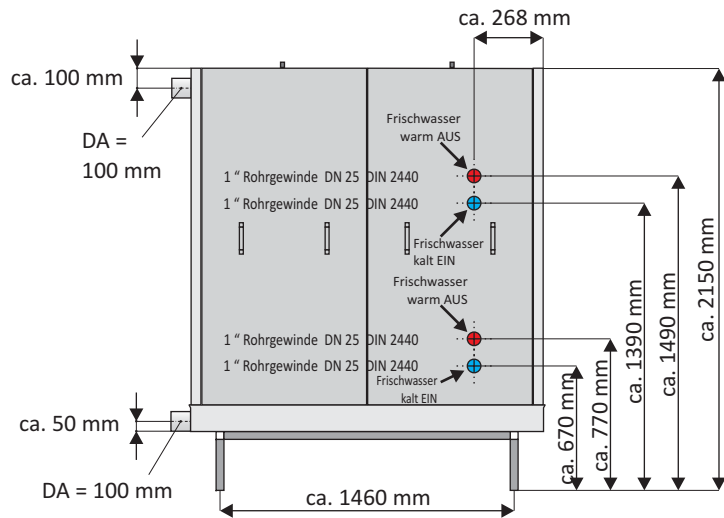

Druckverlust Nutzwasser:

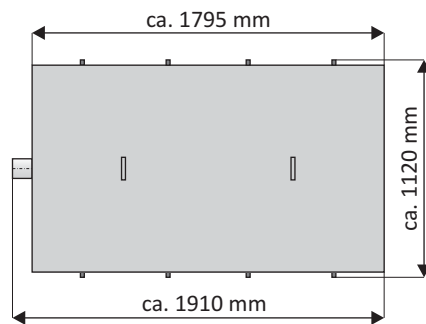
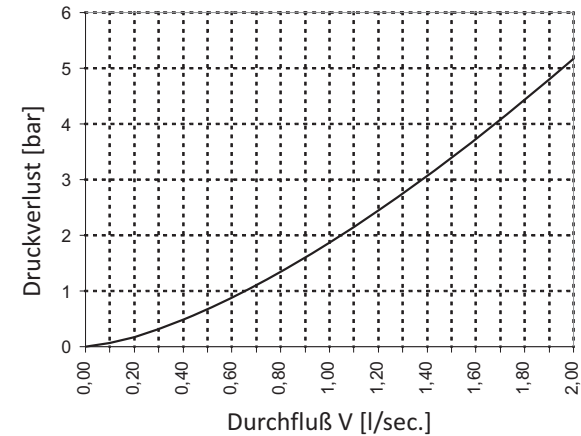

Temperaturkennlinien:

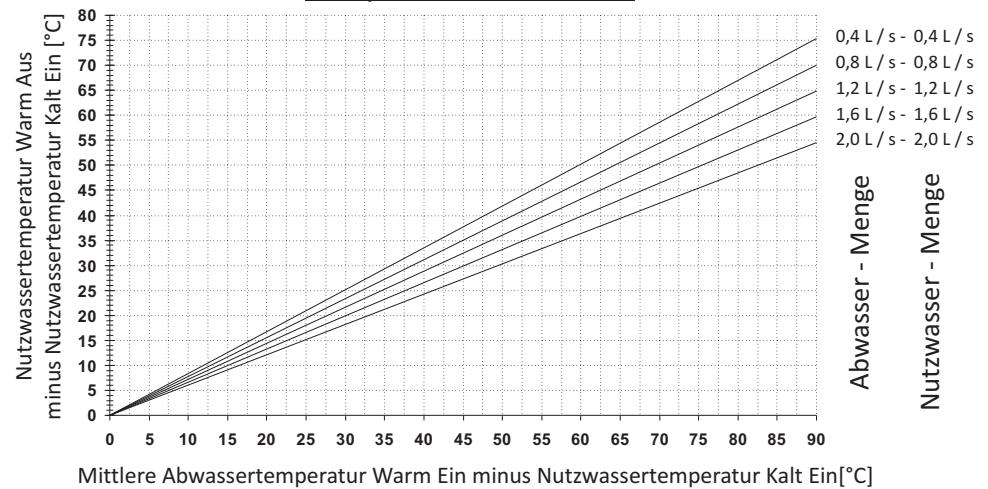

101029

Datenblatt für den FERCHER Abwasserwärmetauscher Typ FB-6/S

6 Norm-Absorber

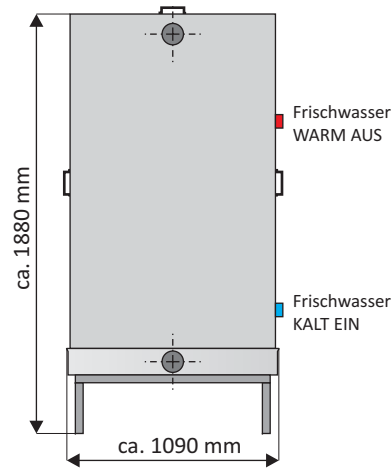
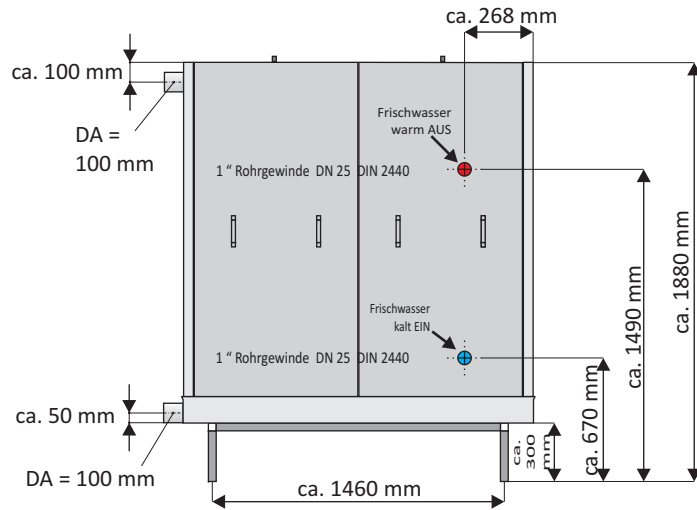

Druckverlust Nutzwasser:

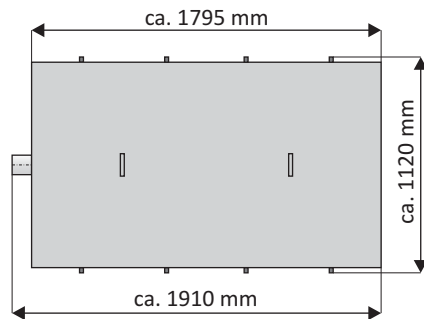
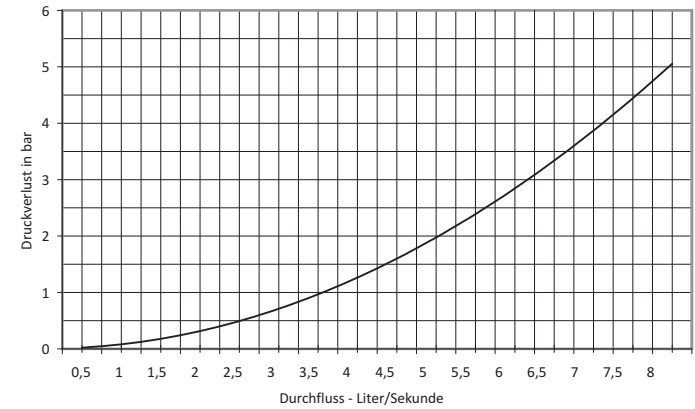

Temperaturkennlinien:

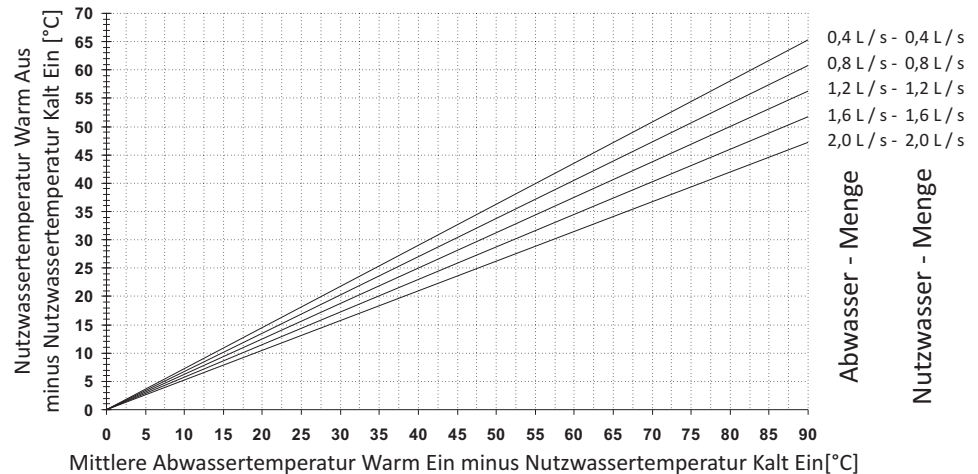

101029

Datenblatt für den FERCHER - Abwasserwärmetauscher Typ FB-4/S

4 Norm-Absorber

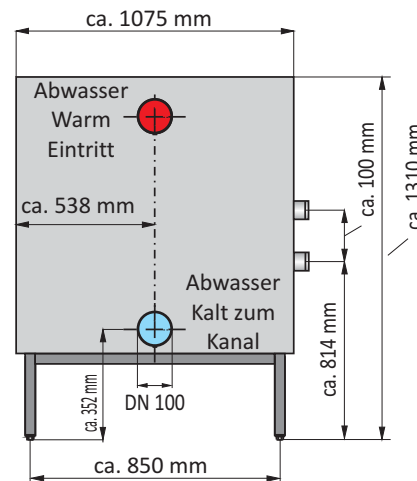
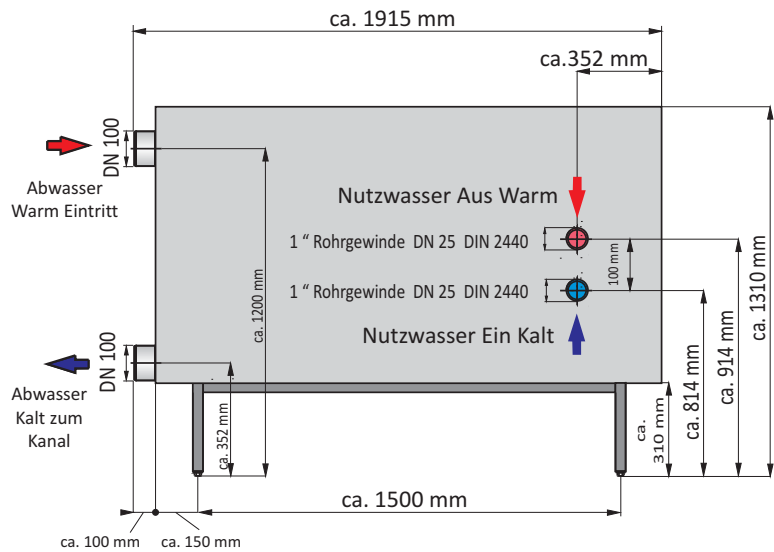

Druckverlust Nutzwasser:

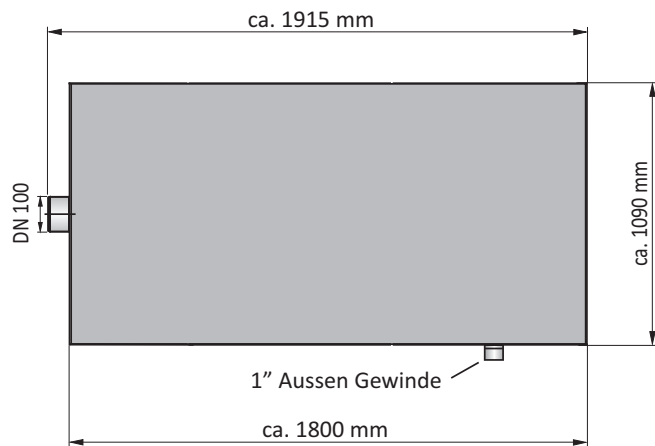
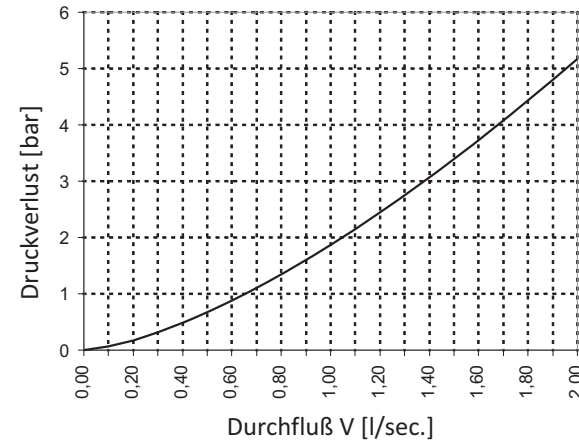

Technische Änderungen vorbehalten

Temperaturkennlinien:

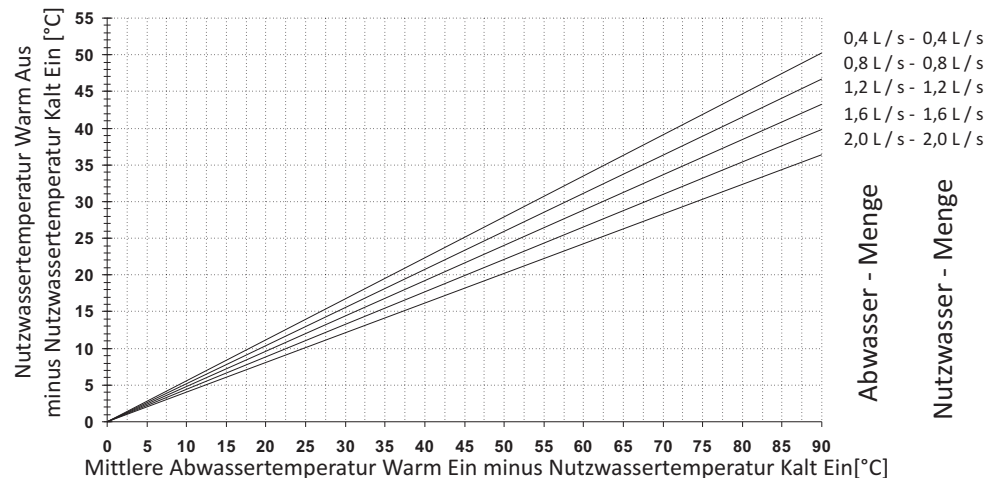

101028

Datenblatt für den FERCHER - Abwasserwärmetauscher Typ FB-2/W

2 Norm-Absorber

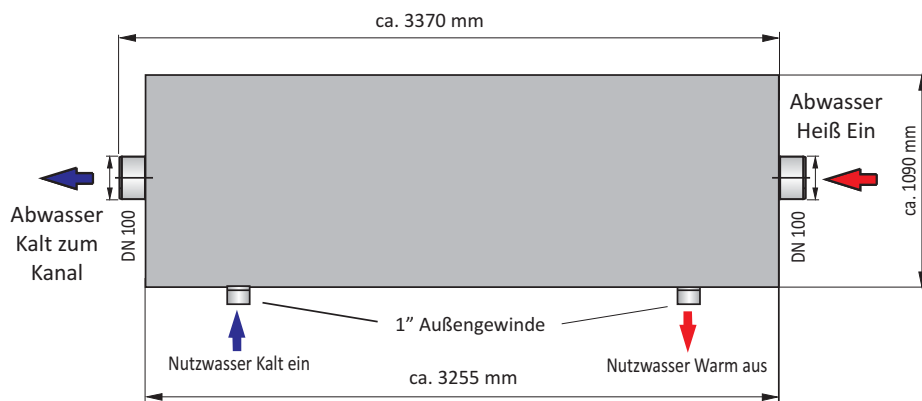
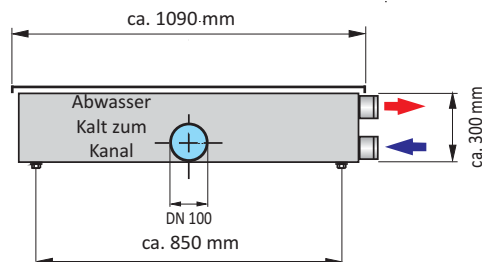
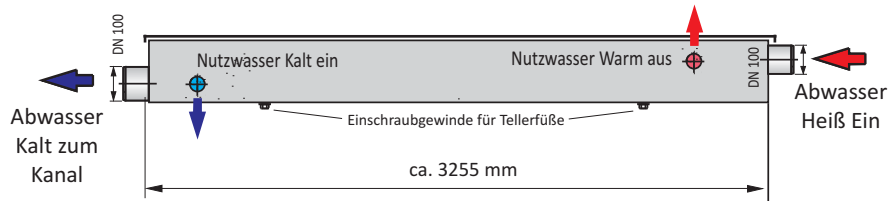

Druckverlust Nutzwasser:

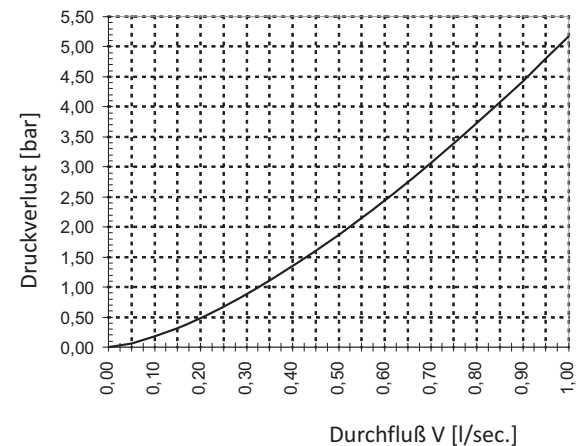

Temperaturkennlinien:

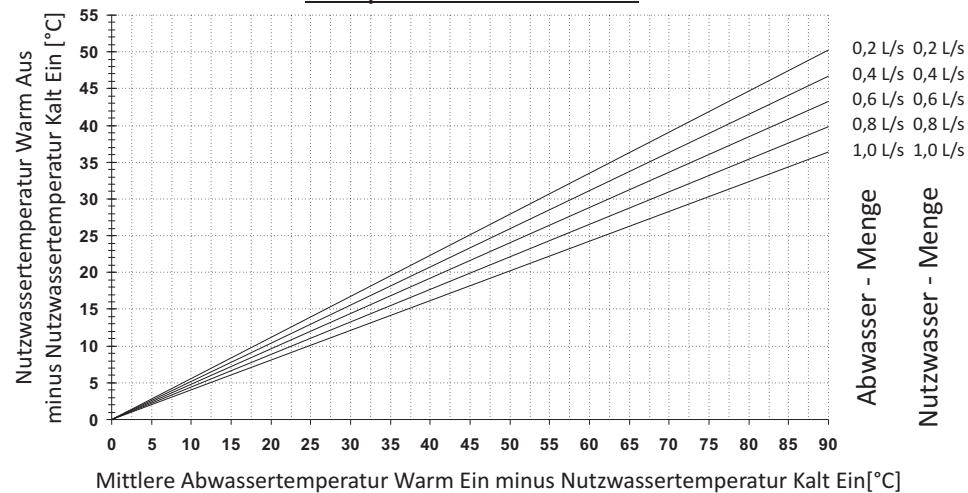

101028

Datenblatt für den FERCHER - Abwasserwärmetauscher Typ FB-2/S

2 Norm-Absorber

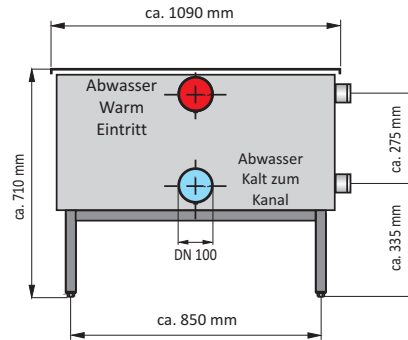
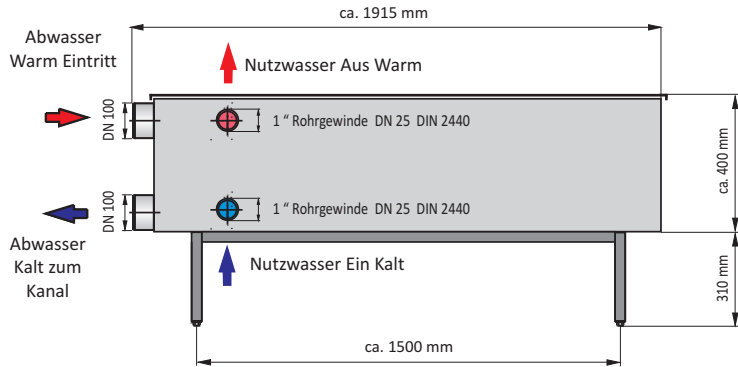

Druckverlust Nutzwasser:

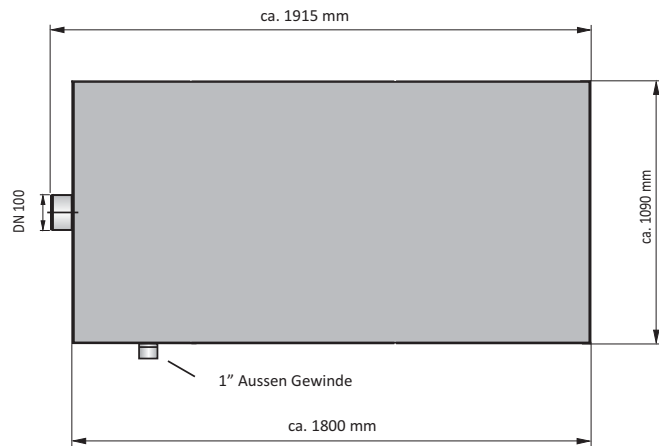
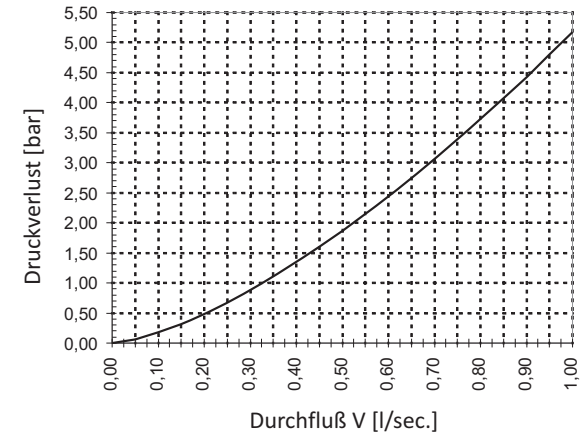

Technische Änderungen vorbehalten

Temperaturkennlinien:

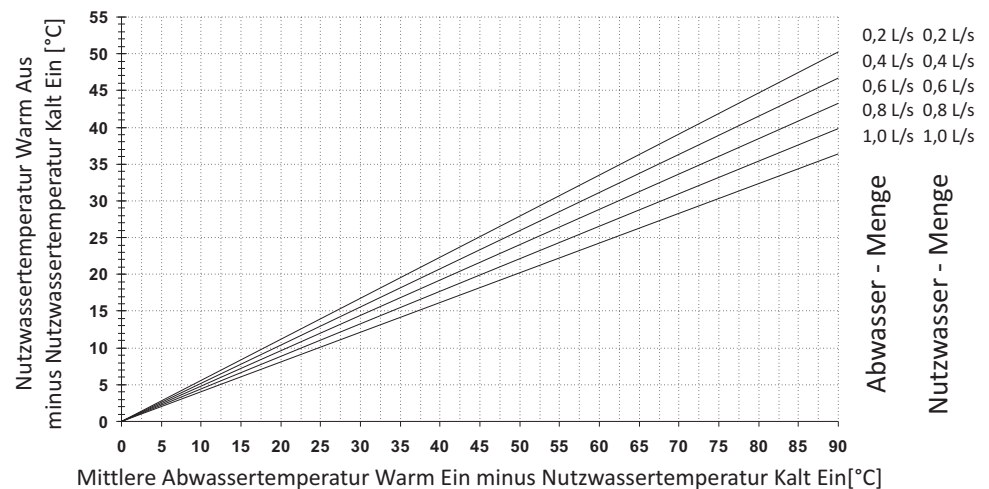

101022

Datenblatt für den FERCHER - Abwasserwärmetauscher Typ FB-1/S

1 Norm-Absorber

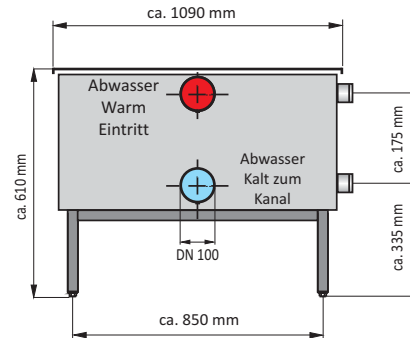
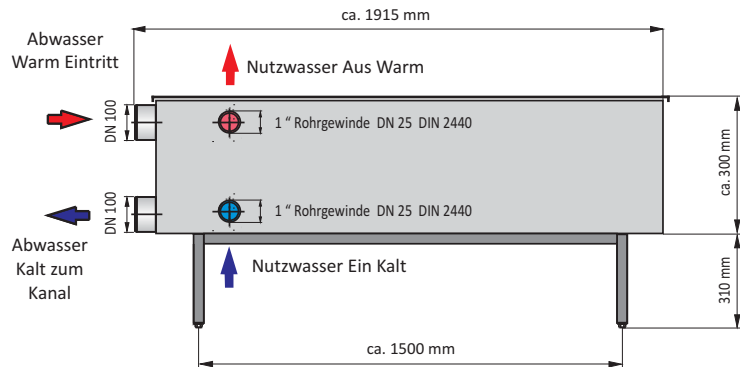

Druckverlust Nutzwasser:

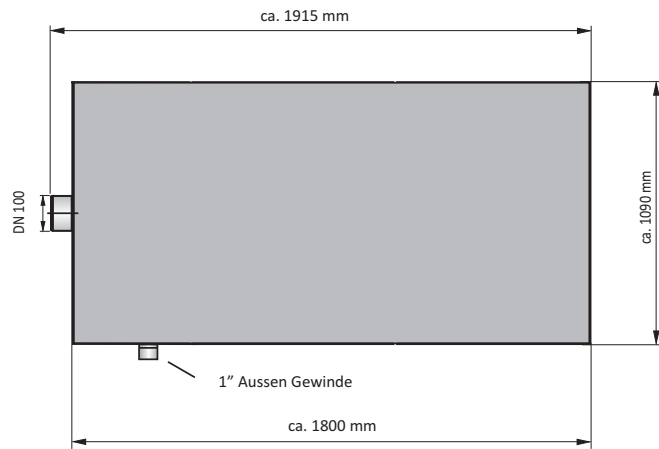
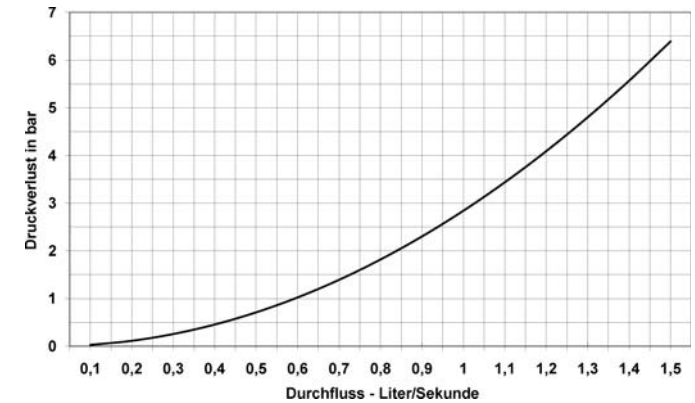

Technische Änderungen vorbehalten

Temperaturkennlinien:

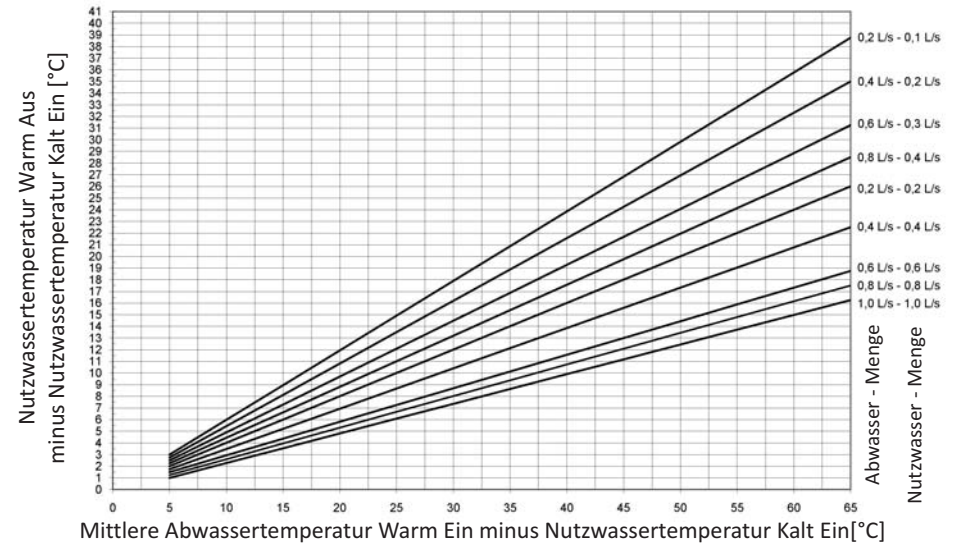

101022